

STRUTTURA:
 Agglomerato di legno foderato con tessuto vellutino termoaccoppiato ad un sottile strato di poliuretano espanso.
IMBOTTITURE:
 Cuscini di seduta in gomma doppia densità 35/28 kg/mc e fibra sintetica 200 g/mc.
 Cuscini di spalliera densità super soft SS 18 kg/mc.
RIVESTIMENTO:
 Interamente sfoderabile.
 Per la variante ecopelle o pelle sfoderabile solo la cuscineria.

STRUCTURE:
 Wooden agglomerate lined with fine velvet fabric thermocoupled to a thin layer of polyurethane foam.
CUSHIONS PADDING:
 Seat cushions rubber in double density 35/28 kg/mc and synthetic fiber 200 g/mc.
 Back cushions density super soft SS 18 kg/mc.
COVER:
 Completely removable.
 In artificial leather or leather removable only cushions.

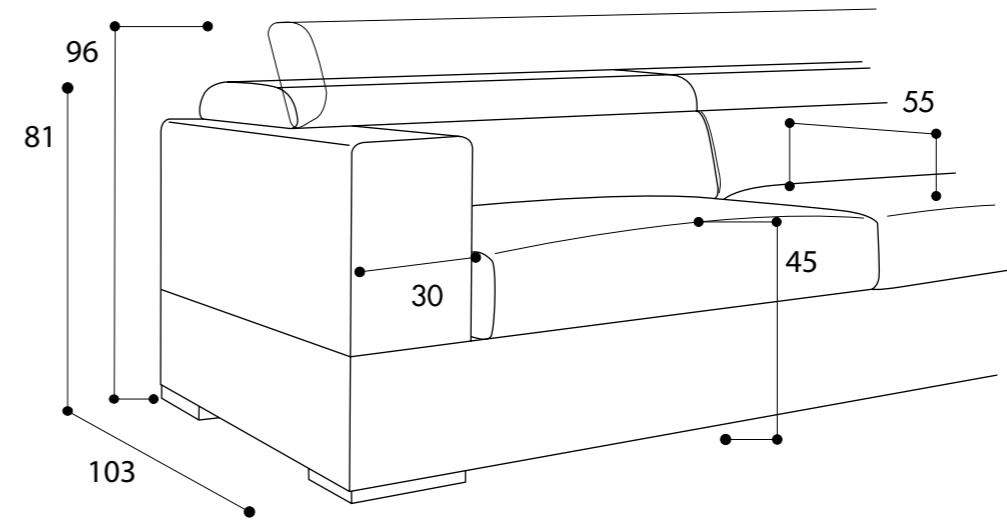

Disponibile con piedini / available with feet /





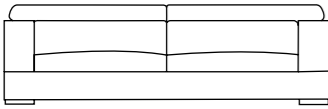
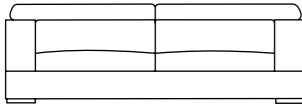
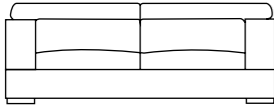
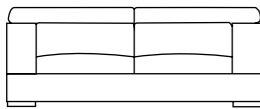
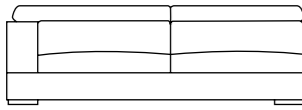
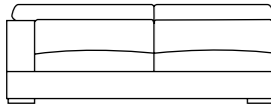

Dimensione con braccioli tipo / Size with armrests type

A

	3 posti max fisso 3,5 places fix	244
	3 posti fisso 3 places fix	224
	Intermedio fisso 2,5 places fix	204
	2 posti fisso 2 places fix	184
	3 posti max laterale fisso - bracciolo DX o SX 3,5 lateral places - armrest DX o SX	214
	3 posti laterale fisso - bracciolo DX o SX 3 lateral places fix - armrest DX o SX	194

Dimensione con braccioli tipo / Size with armrests type

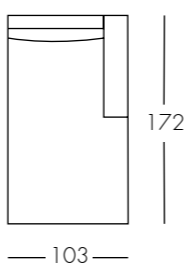
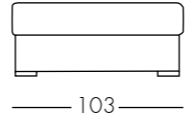
A

	Intermedio laterale fisso - bracciolo DX o SX 2,5 lateral places fix - armrest right or left	174
	2 posti laterale fisso - bracciolo DX o SX 2 lateral places fix - armrest DX o SX	154
	Chaiselongue laterale fissa bracciolo DX o SX Lateral fixed chaiselongue armrest DX o SX	104
 	Pouff fisso/contenitore Fixed/storaged pouf	